



Safety-Trim™

Dual axis servo controller

Models: **ST-2-12v**
ST-2-12v-2sp with 2 speed presets

Safety-Trim is an electronic speed controller designed specifically to operate electric servo motors such as the Ray-Allen T2 and T3 series. Safety-Trim provides the directional switching function as well as the adjustable speed control function needed to drive electric trim motors. Additionally, Safety-Trim provides a time limited operation of the trim servo motors that reduces the possibility of run-away trim conditions. Safety-Trim also has a reverse function switch that will allow recovery to a neutral trim condition even with a failed or inoperative trim switch. Models with 2 speed presets allow Safety-Trim to operate the trim servos at 2 separately adjustable speeds. These speeds are selected by use of an airspeed switch or a flap position switch. This is typically used to select a faster trim movement when the aircraft is at lower speeds and a slower trim movement when the aircraft is at higher speeds.

Safety-Trim is to be used with DC trim motors rated for operation at 12 volts DC and up to 1 amp. No other uses are permitted. Safety-Trim is not TSO'd and must only be used in aircraft certified in the Experimental category.

Safety-Trim also has an output which may be used to power the Ray Allen trim position indicator. (14 volt operation only, up to 100 mAmps maximum)

Compatible wiring harness: model # ST-2-harn

Safety-Trim must be installed using the current aircraft standards and practices. Refer to AC 43.13-2A/1B. The installer/builder is solely responsible for determining the suitability of the installation and use of this product.

Installation instructions:

1) Mount the power switch in a suitable place in the aircraft. It is recommended to mount the switch near the throttle quadrant.

NOTE: If the wires must be removed from the switch during the installation process ensure they are reconnected to their appropriate switch terminals. The 'reverse power' wire must be connected to the momentary action terminal of the power switch. See the wiring chart to confirm connections of the Forward and Reverse power connections. Placard the switch with **ON, OFF , Reverse**. (as shown on the wiring diagram)

2) Connect the RED #20 gauge wire coming from the center terminal of the power switch to + Aircraft Power via a 2 amp fuse.

Connect the BLACK #20 gauge wire to – Aircraft ground. (as shown on the wiring diagram)

3) Connect the trim switch wires to the corresponding wires as shown in the wiring diagram. Each switch (up, down, left, right) is a simple momentary closure to ground. Additionally, switches are simply wired in parallel.

SEE APPLICATION NOTES #1, #2, #3 for typical switch wiring. Note: If using the RAY ALLEN rocker switch RS-2 please note, it is a custom switch that requires special wiring. See application notes for details.

4) Connect the 2 speed switch wire to a switch that will be used to select between high speed and low speed trim operation. The switch provides a closure to ground or pin 7 and may be made with a micro switch, an airspeed switch or a manual switch. SEE APPLICATION NOTES #4, #5 for details.

NOTE: All wiring harnesses include a 2 speed switch connection. (Airspeed switch model ASW-1 available at www.tcwtech.com) If installing a single speed controller, this switch will have no effect. However, if pre-wired in the aircraft it will allow for a simple upgrade in the future to the 2 speed model.

5) It is highly recommended to connect the power wire, ground wire and switch wires first, then temporarily connect the respective trim servo motor wires to verify the trim control surface moves in the correct direction. The polarity of the trim servo motor wires will vary in different aircraft installations and MUST be confirmed in your application. YOU MUST ensure the trim surface moves in the proper direction as activated by the trim switches. You may need to swap the elevator trim motor wires A+, A- to get the elevator trim to go in the proper direction. You may need to swap the aileron trim motor wires B+, B- to get the

aileron trim to go in the proper direction. ONLY after verification of the correct motion should you make permanent connections to the trim servo motors. DO NOT LET THE SERVO WIRES TOUCH EACH OTHER OR GROUND!

6) Mount the Safety-Trim Control box inside the aircraft using the mounting tabs on the enclosure. Orient the control box so that the speed control trim potentiometer(s) is accessible. The control box can be mounted in any orientation. Do not mount the control box in the firewall forward area or in an area likely to get wet.

7) FOR SINGLE SPEED SAFETY-TRIM CONTROLLERS:

The servo speed is controlled by the potentiometer on the side of the enclosure. The range of adjustment is from about 6 to 12 volts. Turning the potentiometer clock-wise increases the speed of the servo.

8) FOR 2 SPEED PRESET SAFETY-TRIM CONTROLLERS:

The two servo speeds are independently set by adjusting the two potentiometers on the side of the enclosure. They are marked Speed 1 and Speed 2. The range of adjustment is from about 5 volts to 12 volts. Turning the potentiometers clock-wise will increase the speed of the servo for each of the two respective preset speeds. The 2 speed switch connected to PIN #8 selects which of the potentiometers is used to control the servo speed. When the 2 speed switch is in the OPEN position, the potentiometer labeled SPEED 1 will set the servo speed. When the 2 speed switch is in the CLOSED position, the potentiometer labeled SPEED 2 will set the servo speed.

PRODUCT OPERATION

NORMAL Operation:

- 1) Place the power switch in the "ON" position.
- 2) Use the trim input switches to drive the respective trim servo in the desired direction.
- 3) If you hold a trim switch closed for more than 3 seconds, the trim servo will stop moving the control surface. If you want more trim authority than commanded in 3 seconds, release the trim switch and press again. This will provide an additional 3 seconds of trim motion.
- 4) Any time you let go of a trim switch, the servo will stop moving.

REVERSE Operation:

If you have a trim input switch fail, either in a closed position or open position you may recover the airplane to a normal trim condition by moving the power switch from the ON position to the Reverse position.

The Reverse position is a momentary closure and you must hold the switch in this position to activate the reverse feature.

- 1) If you experience a failed trim switch in the shorted position your trim system will drive the servo affected for 3 seconds and then stop. To recover the aircraft trim system to a neutral trim condition, simply move the power switch from the ON position to the Reverse position. Hold the power switch in the Reverse position for as long as you need to recover the trim to a neutral setting. Then move the power switch to the OFF position and leave it there for the duration of the flight.
- 2) If you experience a failed trim switch in the open position your trim system will appear to be able drive the trim servo in only one direction. To recover the aircraft trim system to a neutral trim condition, simply move

the power switch from the ON position to the Reverse position. Hold the power switch in the Reverse position for as long as you need to recover the trim to a neutral setting. At the same time, press the trim input switch that is still functional. When the aircraft is properly trimmed, move the power switch to the OFF position and leave it there for the duration of the flight.

TCW Technologies, LLC.
2955 Main Road East
Emmaus, PA 18049

610-928-3420

www.tcwtech.com

Wiring Diagram Model ST-2-12v-2sp

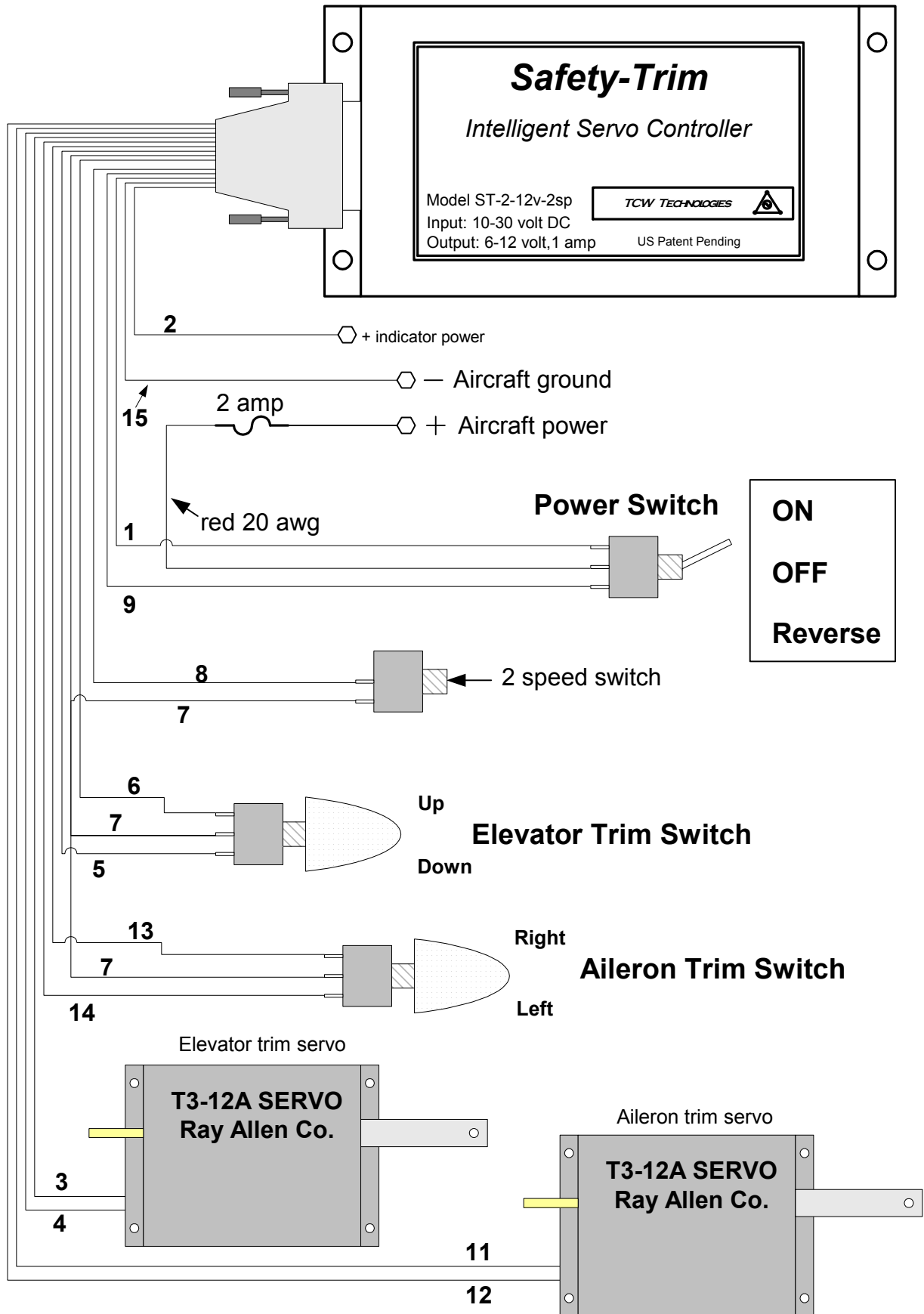

Safety-Trim

Wiring harness chart

Models: ST-2-12v
ST-2-12v-2sp

| 15 pin D-sub connector | | | |
|------------------------|------------------------------|----------------|----------|
| Pin # | Function | Wire | Size |
| 1 | Rev. Power + | Red | 20 gauge |
| 2 | Indicator power + (output) | White | 22 gauge |
| 3 | Elev. Trim motor A+ | Yellow | 22 gauge |
| 4 | Elev. Trim motor A- | Yellow | 22 gauge |
| 5 | UP trim switch terminal | Green | 22 gauge |
| 6 | Down trim switch terminal | Green | 22 gauge |
| 7 | Switch center terminal (grd) | Black | 22 gauge |
| 8 | 2 speed switch | White w/black | 22 gauge |
| 9 | Forward Power + | White | 20 gauge |
| 10 | | | |
| 11 | Aileron Trim motor B+ | Orange | 22 gauge |
| 12 | Aileron Trim motor B- | Orange | 22 gauge |
| 13 | Left trim switch terminal | Blue or Purple | 22 gauge |
| 14 | Right trim switch terminal | Blue or Purple | 22 gauge |
| 15 | Ground - | Black | 20 gauge |

NOTES:

- 1) All switches share a common ground , Pin7.
A separate chasis ground may be used instead of pin 7 in retrofit applications
- 2) Any unused wires must be capped off
- 3) Connect all power wires and trim switch wires first, then test trim motor polarity required for your specific plane. You may need to swap the A+ and A- connections for the elevator trim or you may need to swap the B+ and B- connections for the aileron trim.
- 4) Pin 2 may be used to power the Ray-Allen bargraph indicator or equiv.
- 5) Pin 8 is for models having 2 adjustable speed presets
- 6) Additional trim switches are simply wired in parallel, no extra diodes or relays required when using standard momentary SPST or SPDT switches. See application notes.
- 7) Pin #2, indicator power, may be used to provide up to 100 mAmps of unregulated power to indicators such as the Ray Allen bargraph position indicator

Application Note #1

Multiple Switch Wiring Details

TYPICAL "hat switch" wiring, each switch is a momentary type

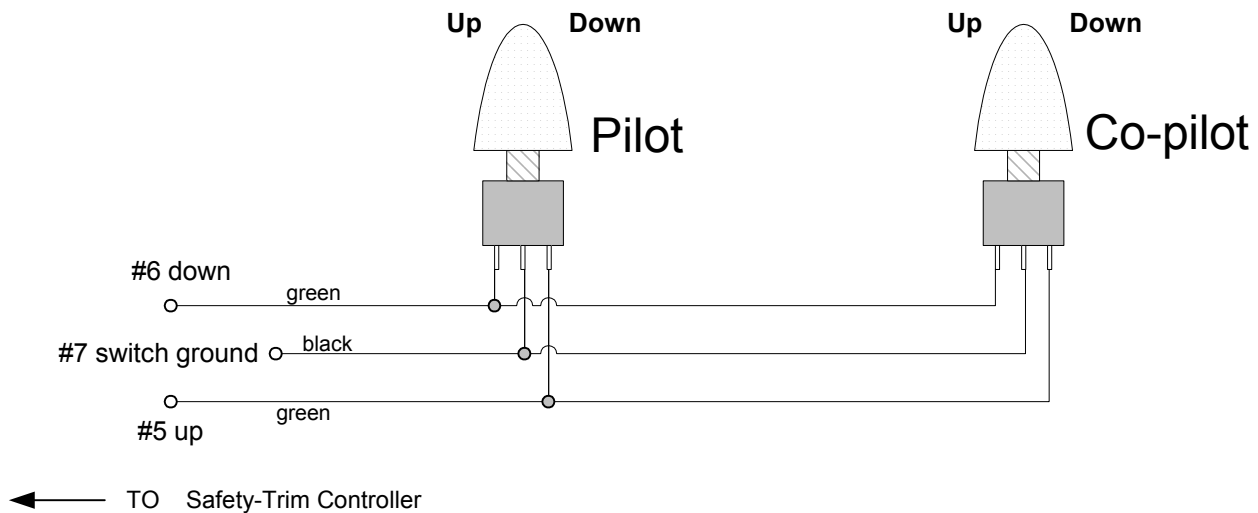

Note: Aileron or Rudder trim switches may be wired in the same manner.

Note: Additional STANDARD SPST and SPDT switches may be wired in parallel

Note: See Application Note #2 and #3 for details on RAY ALLEN Rocker Switch RS2

Application Note #2

Using Ray Allen RS 2 Rocker switch with additional "hat switches"

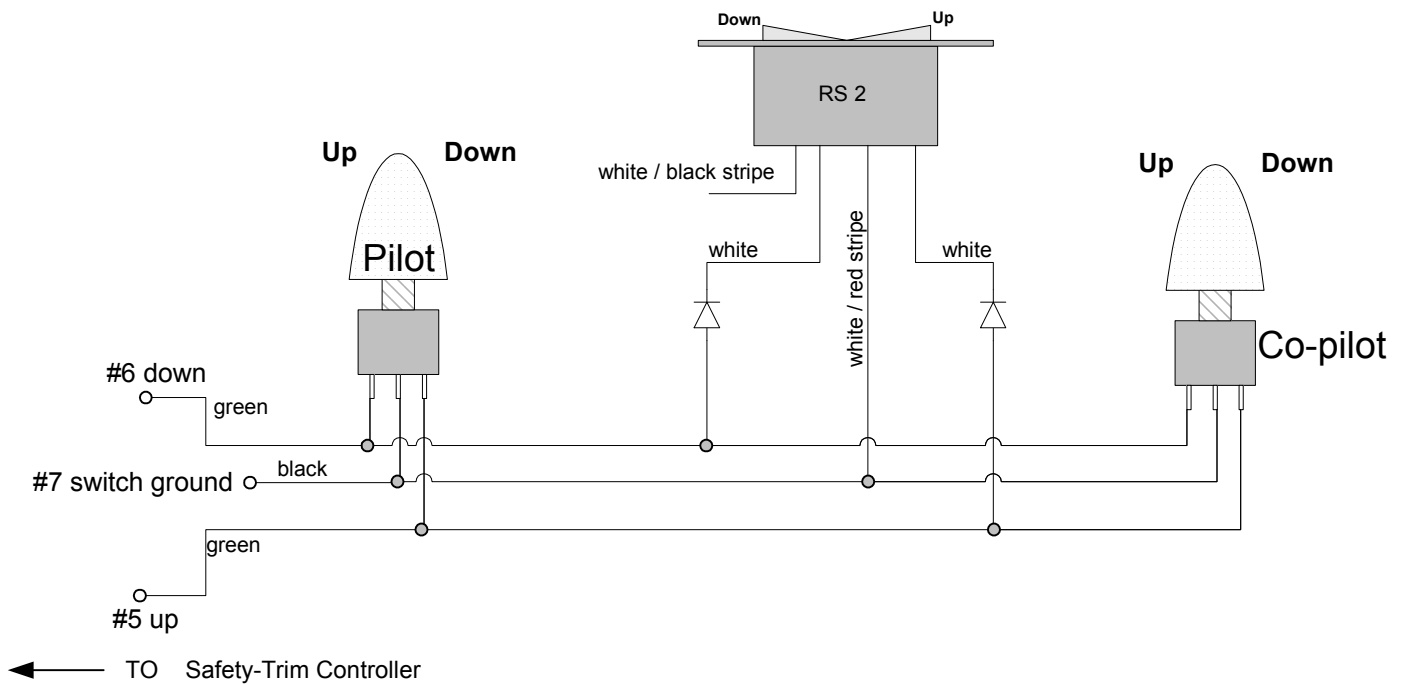

Note: Diodes may be any general purpose diode such as 1N914 or 1N4004

Note: RAY ALLEN Rocker Switch RS2 is of a custom design, in the neutral position the white wires are shorted together

Note: Aileron or Rudder trim switches may be wired in the same manner.

Application Note #3

Using Ray Allen RS 2 Rocker switch with no other switches

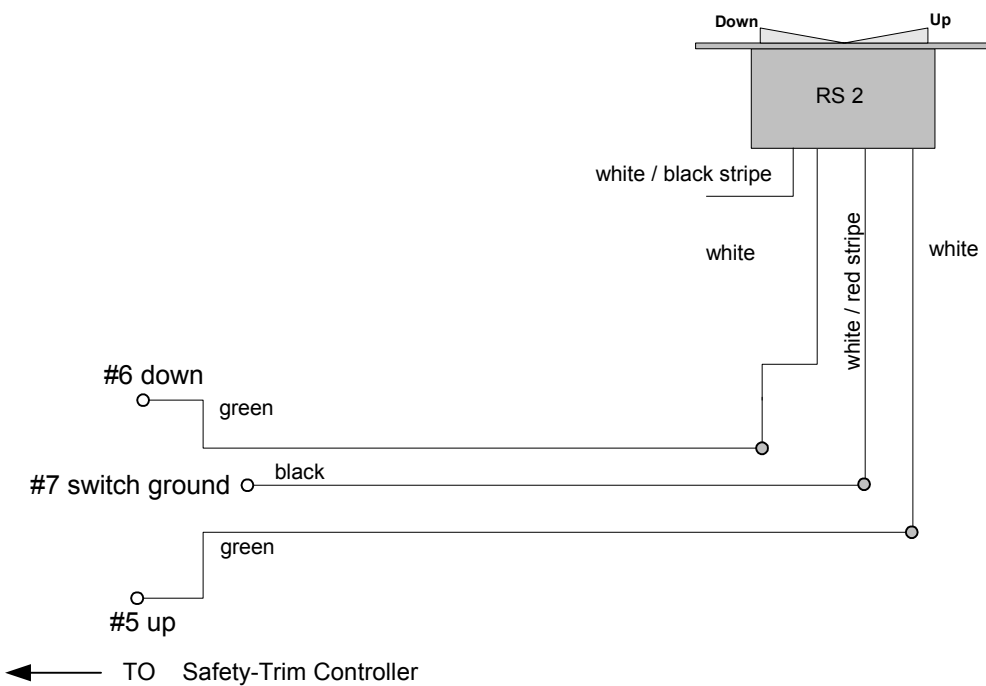

Note: RAY ALLEN Rocker Switch RS2 is of a custom design, in the neutral position the white wires are shorted together

Note: Aileron or Rudder trim switches may be wired in the same manner.

Application Note #4

2 speed switch detail

Mount a micro-switch near the flap torque tube. Attach a small bracket to the torque tube that activates the 2 speed switch when the flaps are retracted

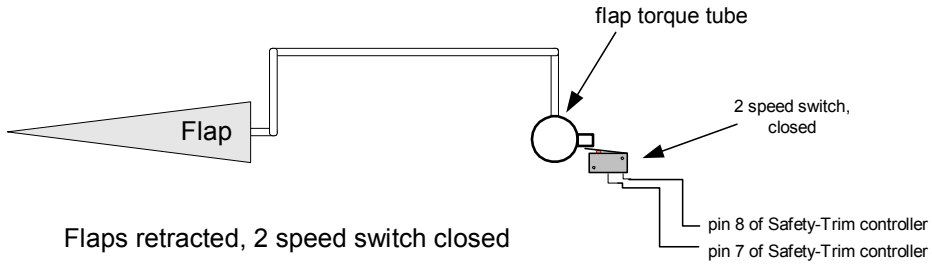

"Speed 2 selected"

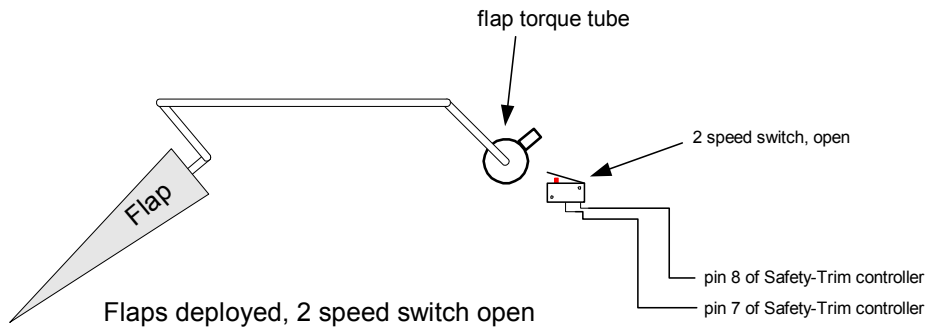

"Speed 1 selected"

Application Note #5

ASW-1

Airspeed Switch for 2 speed selection of Safety-Trim

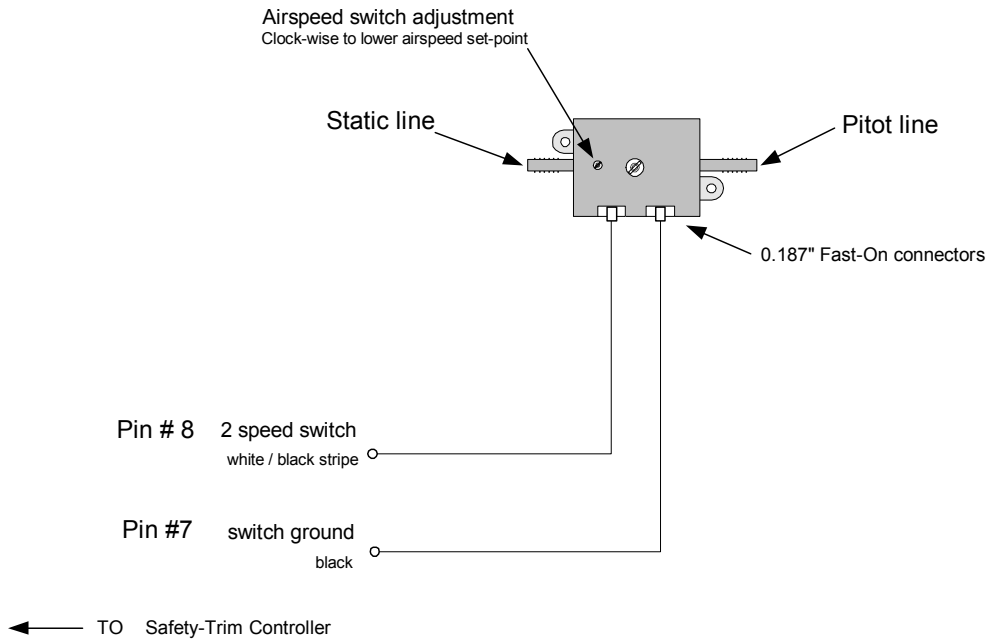

Note: Pin #7 is a common switch ground for all trim switches and the airspeed switch. An airframe ground may be used as an alternative

Note: Adjustment ranges is about from 55 knots to 140 knots. Factory calibrated to 100 knots.

Rev 1, Dec 22, 2007
Safety-Trim
Airspeed Switch wiring detail

TCW Technologies, LLC.

During the first 24 months from the date of purchase and subject to the conditions hereinafter set forth, TCW Technologies, LLC. (TCW) will repair or replace to the original user or consumer any portion of your new Safety-Trim product which proves defective due to defective materials or workmanship of TCW. Contact TCW Technologies for warranty service. TCW shall have and possess the sole right and option to determine whether to repair or replace defective equipment, parts or components. Damage due to equipment, environment or conditions beyond the control of TCW Technologies are NOT COVERED BY THIS WARRANTY.

LABOR, COSTS: TCW shall IN NO EVENT be responsible or liable for the cost of field labor or other charges incurred by any customer in removing and/or reaffixing any TCW product, part or component thereof.

THIS WARRANTY WILL NOT APPLY: (a) to defects or malfunctions resulting from failure to properly install, operate or maintain the unit in accordance with printed instructions provided; (b) to failures resulting from abuse, accident, or negligence; (c) to normal maintenance services and the parts used in connection with such service; (d) to units which are not installed in accordance good trade practices; or (e) to unit used for purposes other than for what it was designed and manufactured.

RETURN OR REPLACED COMPONENTS: any item to be replaced under this Warranty must be returned to TCW Technologies in Emmaus, PA, or such place as TCW may designate, freight prepaid.

PRODUCT IMPROVEMENTS: TCW reserves the right to change or improve its products or any portions thereof without being obligated to provide such a change or improvement for units sold and /or shipped prior to such change or improvement.

WARRANTY EXCLUSIONS: as to any specific TCW product, after the expiration of the time period of the warranty applicable thereto as set forth above. THERE WILL BE NO WARRANTIES, INCLUDING ANY IMPLIED WARRANTIES OR MERCHANTABILITY OR FITNESS FOR ANY PARTICULAR PURPOSE.

Some states do not allow limitations on how long an implied warranty lasts, so the above limitation may not apply to you. No warranties or representations at any time made by any representative of TCW shall vary or expand the provisions hereof.

LIABILITY LIMITATION: IN NO EVENT SHALL TCW OR ITS AFFILIATES BE LIABLE OR RESPONSIBLE FOR CONSEQUENTIAL, INCIDENTAL OR SPECIAL DAMAGES RESULTING FROM OR RELATED IN ANY MANNER TO ANY TCW PRODUCT OR PARTS THEREOF. THE SUITABILITY OF USE OF THE SAFETY-TRIM PRODUCT IS TO BE DETERMINED BY THE AIRCRAFT HOMEBUILDER.

Some states do not allow the exclusion or limitation of incidental or consequential damages, so the above limitation or exclusion may not apply to you.

This Warranty gives you specific legal rights and you may also have other rights which vary from state to state. In the absence of other suitable proof of this installation date, the effective date of this Warranty will be based upon the date of manufacture plus one year. Direct All Notices To: Warranty and Product Service Department, TCW Technologies, 4906 Raymond Ct. Emmaus, PA 18049